

Grade	A	B	C	V
0-100	±0.10	±0.10	±0.10	±0.10
100-200	±0.15	±0.15	±0.15	±0.15
200-300	±0.20	±0.20	±0.20	±0.20
300-400	±0.25	±0.25	±0.25	±0.25
400-500	±0.30	±0.30	±0.30	±0.30
500-600	±0.35	±0.35	±0.35	±0.35
600-700	±0.40	±0.40	±0.40	±0.40
700-800	±0.45	±0.45	±0.45	±0.45
800-900	±0.50	±0.50	±0.50	±0.50
900-1000	±0.55	±0.55	±0.55	±0.55

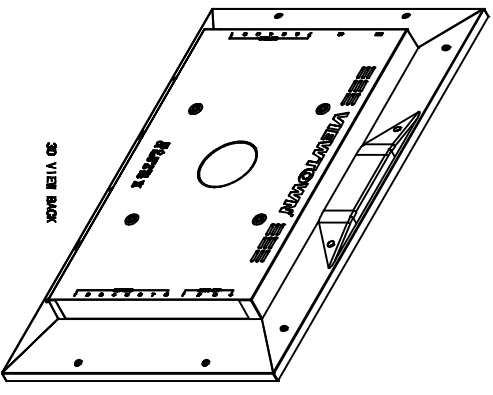
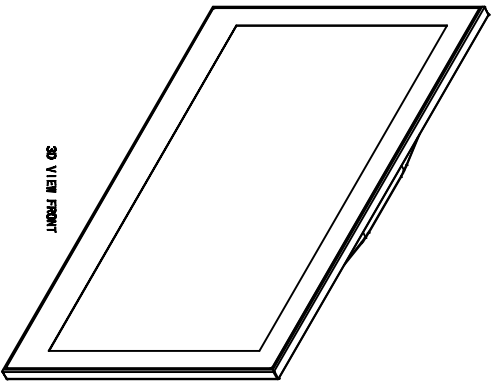
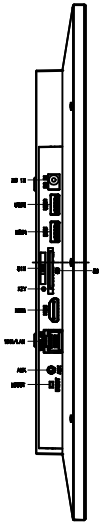
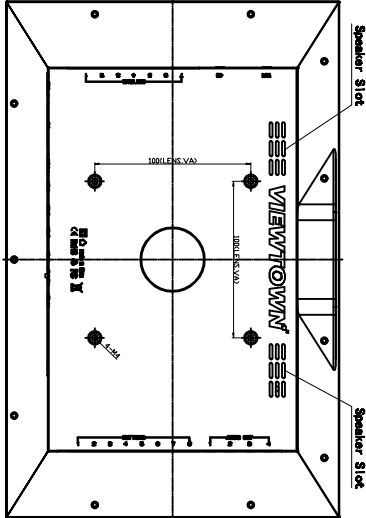
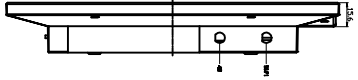
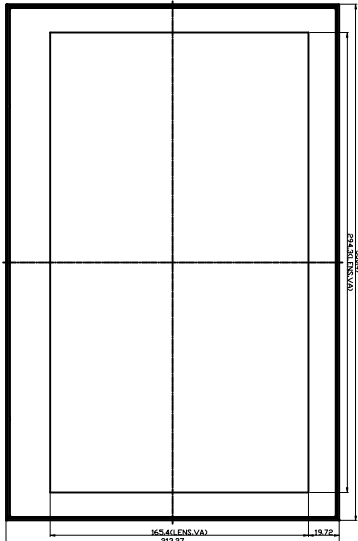
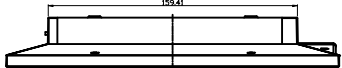
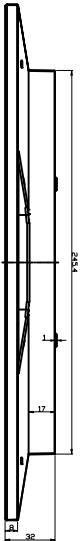

NOTE:
 1、 This product is 13.3 inch advertising machine;
 2、 The shell material of the product is plastic.

KERCHAN
 Professional Innovation
Kerchan Technology Group Limited

图号 Drawing No.	SAD1330KA-TOUCH
物料编号 Material No.	xxxxxxxx
比例 Scale	1:1
版本号 Rev	A/0
单位 Unit	MM

更改说明及标注 Description	RCN号 RCN No.	签名 Signed	日期 Date
设计 Designed By	日期 Date	20210330	
审核 Checked By	日期 Date		
批准 Approved By	日期 Date		

第 1 页 共 1 页
 Sheet 1 of 1

图形识别符号
Graphic identification symbols

名称
Name:
 13.3 Inch advertising
 product drawing (DS-830)