

Size	Grade		
	A	B	C
0-80	±0.05	±0.10	±0.15
>80-100	±0.10	±0.15	±0.20
>100-150	±0.15	±0.20	±0.30
>150-200	±0.20	±0.30	±0.40
>200-300	±0.25	±0.40	±0.50
>300-500	±0.30	±0.50	±0.60
>500以上	±0.50	±0.80	±1.00

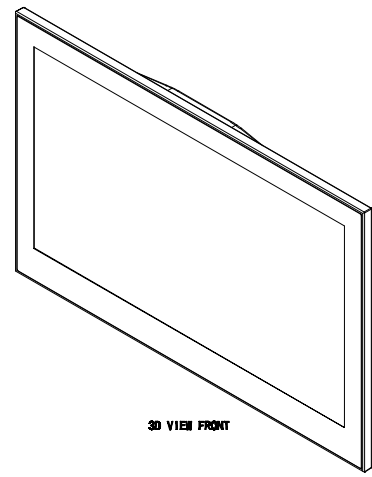

3D VIEW FRONT

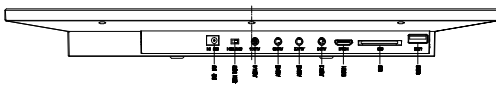
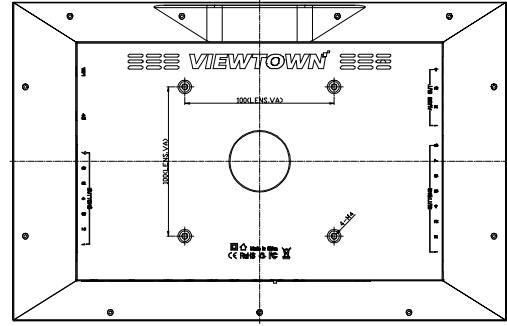
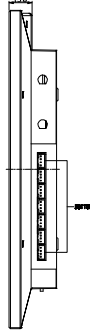
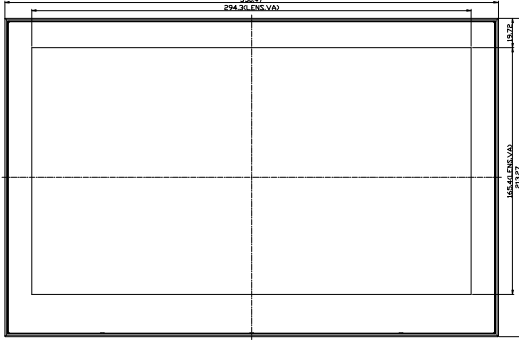
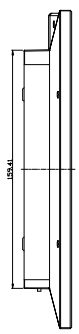
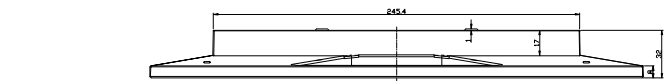
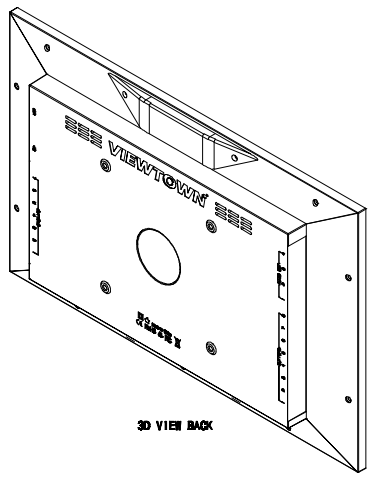

3D VIEW BACK

NOTE:  
1、This product is 13.3 inch advertising machine.

**KERCHAN**  
Professional Innovation  
Kerchan Technology Group Limited

版本号 Rev	单位 Unit	比例 Scale	图号 Drawing No.
A/0	MM	1:1	SAD1330H-00
第 1 页 共 1 页 Sheet 1 of 1			物料编码 Material No.
图形识别符号 Graphic identification symbols			名称 Name:
			13.3 inch advertisting product drawing (YF-V56)

更改说明及标注 Description	ECN号 ECN No.	签名 Signed	日期 Date
设计 Designed By		JOE	日期 Date
审核 Checked By			日期 Date
批准 Approved By			日期 Date

ECN号 ECN No.	签名 Signed	日期 Date
		20200118